



Date .....	Order .....	User .....	Address .....
------------	-------------	------------	---------------

<b>Handle tube</b>			02958
<input checked="" type="radio"/> Tubes with standard handle			
<input type="radio"/> Folding handles Not available with: Push handles for companion, Brake handles for companion (Drum Brake)			

<b>Colour set: Includes rear wheel hub and rim, rear wheel plates and front forks</b>			
Only standard Progeo 22"/24" wheels have coloured hubs and rims			
<input checked="" type="radio"/> Black	22" 24" 25" 26"		
<input type="radio"/> POLAR white	22" 24"		00833
<input type="radio"/> Matt grey	22" 24"		00833
<input type="radio"/> Matt Midnight blue	22" 24"		00833
<input type="radio"/> Matt red	22" 24"		00833
<input type="radio"/> Neon Green	22" 24"		00833
<input type="radio"/> Mercury Grey	22" 24"		00833
<input type="radio"/> Pop Magenta	22" 24"		00833

<b>Casters</b>			
<input checked="" type="radio"/> 5" Soft			
<input type="checkbox"/> 4" Soft			
<input type="checkbox"/> 3" Sport	<i>Lightest configuration</i>		
<input type="checkbox"/> 6" Soft	Not available with frame angle 95°		
<input type="checkbox"/> 6" Pneumatic	Not available with frame angle 95°		
<input type="checkbox"/> 7" Soft	Not available with frame angle 95°		
<input type="radio"/> 3" Active Soft (wide)	(Aluminium alloy rim)		06824
<input type="radio"/> 4" Active Sport (narrow)	(Aluminium alloy rim)		01398
<input type="radio"/> 4" Active Soft (wide)	(Aluminium alloy rim)		03943
<input type="radio"/> 5" Active Soft (wide)	(Aluminium alloy rim)		07518
<input type="radio"/> 5" Pneumatic			10844

<b>Rear wheels</b>			
<input checked="" type="radio"/> 24" Ultra-light Progeo - Standard!			
<input type="checkbox"/> 22" Ultra-light Progeo - Standard!			
<input type="checkbox"/> 25" Ultra-light Progeo - Standard!	(colour: black)		
<input type="checkbox"/> 26" Progeo - Standard!	(colour: black)		
<input type="radio"/> 24" ULTRA-LIGHT PROGEO KEY SPORT	<i>Lightest configuration</i>		04383
<input type="radio"/> 24" Ultra-light "Spinergy LX"			01685
<input type="radio"/> 24" Ultra-light "Spinergy LXL"	<input type="checkbox"/> Black hub and white spokes	<input type="checkbox"/> Hub and spokes black	07846
<input type="radio"/> 24" Ultra-light "Spinergy Flex rim"	Integrated aluminium/rubber handrim		02270
<input type="radio"/> 25" Ultra-light "Spinergy LX"			02101
<input type="radio"/> 25" Ultra-light "Spinergy LXL"	<input type="checkbox"/> Black hub and white spokes		07847
<input type="radio"/> 26" Ultra-light "Spinergy LX"			02102
<input type="radio"/> 24" Off-road (aluminium handrim black - Wheel distance 4cm)			01392
<input type="radio"/> 24" with brake handles for companion (drum brake) (aluminium handrim - Wheel distance 3cm)			03384
Available only with camber 0°			
<input type="radio"/> One arm drive - (24" rear wheels Aluminium handrim High pressure Tyre) - camber 0°			
	<input type="radio"/> Right <input type="radio"/> Left		02103

<b>Rear wheel tyre</b>			
<input checked="" type="radio"/> High pressure tyre	(22"-24"-25"-26")	<i>Lightest configuration</i>	
<input type="checkbox"/> High pressure profile tyre	(24")		
<input type="radio"/> Marathon Plus	(24"-25")	with anti-puncture protection	01669
<input type="radio"/> Anti-puncture - Colour Black	(24")		11083
Not available with Rear wheels : 24" ULTRA-LIGHT PROGEO KEY SPORT, 24" Ultra-light "Spinergy LXL"			
<input type="radio"/> Anti-puncture - Colour Grey	(22")		04181

<b>Handrim</b>		<b>Wheel distance <input checked="" type="checkbox"/> 3 cm    <input type="checkbox"/> 4 cm</b>	
<input checked="" type="radio"/> Aluminium	(22"-24"-25"-26")	<i>Lightest configuration</i>	
<input type="radio"/> Aluminium black SOFT-TOUCH	(24"-25")	(24" handrim, on 25" wheel is installed with spacers)	09170
<input type="radio"/> Chromed Steel	(24"-25")	(24" handrim, on 25" wheel is installed with spacers)	01684
<input type="radio"/> Titanium	(24"-25")	(24" handrim, on 25" wheel is installed with spacers)	00016
<input type="radio"/> Ultra Grepp	(24"-25")	(24" handrim, on 25" wheel is installed with spacers)	00017
<input type="radio"/> TOP FRICTION	(24"-25")	(24" handrim, on 25" wheel is installed with spacers)	11023
Oval countour with a rubber insert			
<input type="radio"/> NOVA H	(24"-25")	(24" handrim, on 25" wheel is installed with spacers)	11025
Ergonomic black profile			
<input type="radio"/> NOVA D	(24"-25")	(24" handrim, on 25" wheel is installed with spacers)	11026
Ergonomic profile with rubber coating (ideal for quadriplegics)			
<input type="radio"/> Silicon cover for standard aluminium handrim		Available for measures (22"- 24" - 26")	04050



Date ..... Order ..... User ..... Address .....

**Wheel locks**

Bent lever push to lock 

Straight lever push to lock 

Straight lever pull to lock

Sport brake  06428

Brake with extension lever push to lock  01949

Brake with extension lever pull to lock  03372

**Footplate (Not available with Elevating front frame, swing away and removable) - See reference tables N°3**

Plastic footrest, rake adjustable  
Not available with Elevating front frame, swing away and removable  
Minimum footplate distance 27cm.  2/3 Internal  2/3 External  11525

One piece footplate - Flip-up! rake and depth adjustable  
Not available with Elevating front frame, swing away and removable  
Minimum footplate distance 24cm.  Internal  2/3 Internal  External  11527

Minimum footplate distance 21cm. Available only with Multi-function and rotative system - 03945 194,00

One piece aluminium footplate - Flip-up! rake and depth adjustable  
Not available with Elevating front frame, swing away and removable  
Minimum footplate distance 24cm.  Internal  2/3 Internal  2/3 External  External  11528

One piece Carbon fibre footplate rake adjustable, swing away, flip-up.  
Not available with Elevating front frame, swing away and removable  
Minimum footplate distance 24cm.  Internal  External  03291

**Mudguard**

**Mudguard - ADJUSTABLE**

Plastic mudguard  12648

**Mudguard enlargement**

+ 0 cm

+ 1 cm  + 2 cm

**Mudguard - FIXED - made-to-measure**

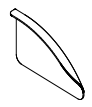
ABS mudguard  03946

ABS Straight sideguard 08918

Carbon fibre mudguard

Carbon fibre Straight sideguard

Mudguard enlargement

+ 0 cm

+ 1 cm  + 2 cm Not available with Rear wheels with brake handles for companion (Drum Brake) 12648

**Mudguard - REMOVABLE**

*The distance between the two side guards is 1 cm wider than the seat width*





Removable ABS mudguard 08921

Removable ABS fibre straight sideguard  08921





Removable carbon fibre mudguard 08919



Removable Carbon fibre straight sideguard 08920

Date .....	Order .....	User .....	Address .....
------------	-------------	------------	---------------

<b>Armrests</b>			
<i>Tubular armrests with standard support combined with anti-tipper wheels exclude the possibility of installing the transit wheels.</i>			
<input type="radio"/> Tubular armrests	(Swing away, removable and height adjustable armrest) <input type="radio"/> Standard Support <input type="radio"/> Steel support with safety locking system		04828 00694
<b>Removable armrest with integrated mudguard</b>			
<input type="radio"/> Desk armrests PROGEO	(Removable and height adjustable)		09956
<b>Enlargement of Desk armrests PROGEO</b>			
<input type="checkbox"/> ☆ + 0 cm	Available only with Ultra-light Progeo standard wheels and camber 0°		12648
<input type="checkbox"/> □ + 2 cm			
<input type="radio"/> Flip-up armrests PROGEO	(Removable and height adjustable)		12277
<input type="radio"/> Removable armrest with ABS straight sideguard	<i>The distance between the two side guards is 1 cm wider than the seat width</i>		08881
<input type="radio"/> Removable armrest with carbon-fiber straight sideguard	<i>The distance between the two side guards is 1 cm wider than the seat width</i>		08882

<b>Accessories</b>			
<input type="radio"/> Pad for front frame protectors			07058
<input type="radio"/> Backrest-seat connection cloth			10241
<input type="radio"/> Removable storage bag (with quick coupling)			09811

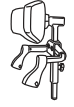
<b>Optional 1</b>			
<input type="radio"/> Transit wheels			00836
<input type="checkbox"/> Anti-tipper with rapid hookup	(inside rotation to reduce the encumbrance) <input type="radio"/> Right <input type="radio"/> Left		00023 00024
<input type="radio"/> Tipping aid	<input type="radio"/> Right <input type="radio"/> Left		00025 01046
<input type="radio"/> Crutches support	<input type="radio"/> Right <input type="radio"/> Left		00838 00837

<b>Optional 2</b>			
<input type="radio"/> Tetracrip	(Quick release axle for quadriplegic)		03947
<input type="radio"/> Rear wheels plate extension			01950
<input type="radio"/> Handybike adaptor			00506
<input type="radio"/> Push handles for companion	(Removable and height adjustable)		01048
<input type="radio"/> Harness			04103
<input type="radio"/> Safety pelvic belt			03972
<input type="radio"/> Tray table (removable)			00508
<input type="radio"/> Lumbar support	(to insert in the backrest upholstery)		00013
<input type="radio"/> Super Head rest	(Folding with the wheelchair)		04049
<input type="radio"/> Swing away lateral support	<input type="radio"/> Right <input type="radio"/> Left		02097 02098
<input type="radio"/> Spoke guards Black	(22"-24")		01043
<input type="radio"/> Spoke guards Transparent	(22"-24")		00835
<input type="radio"/> Spoke guards Progeo design	(22"-24")		00019

<b>Additional Kit</b>			
<input type="radio"/> 24" Off-road rear wheels	Off-Road tyre - aluminium handrim (black colour)		03378
<input type="radio"/> 24" FAT rear wheels	FAT tyre 3" - aluminium handrim (black colour)		09357

Date ..... Order ..... User ..... Address .....

**Removable with quick release**  
**Suitable for tubes with diameter 18+26mm**  
**Depth adjustment (4cm)**  
**Angle adjustment (±18°)**

- AIR** Carbon shell  
not available for seat width 48

BACKREST HEIGHT	28	34	40			
Shell's shape  7,5 cm	Lateral retaining wing A=high - R=regular					
	A	R	A	R	A	R
	<input type="checkbox"/>	<input type="checkbox"/>	<input type="checkbox"/>	<input type="checkbox"/>	<input type="checkbox"/>	<input type="checkbox"/>

- POSTURE** Aluminum shell

BACKREST HEIGHT	34	40	52
Shell's shape  7,5 cm	Lateral retaining wing R=regular		
	R	R	R
	<input type="checkbox"/>	<input type="checkbox"/>	<input type="checkbox"/>



Aluminum lateral with padded, breathable upholstery.



Small (h 13cm)		Large (h 20cm)	
	<input type="radio"/> Right 10272		<input type="radio"/> Right 10273
	43,00		
	<input type="radio"/> Left 10272		<input type="radio"/> Left 10273
	43,00		

**SWING AWAY - Lateral support**

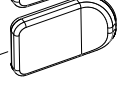
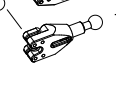
Fixing and adjustment hardware complete with protection sleeve  
 Alluminum lateral with padded, breathable upholstery.

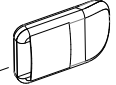
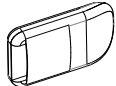
	<input type="radio"/> Large (18x12)	05647
	<input type="radio"/> Small (14x9)	05643
	<input type="radio"/> Lateral support extension	Quantity (number pcs)..... 10271
	<input type="radio"/> Lateral support extension	Quantity (number pcs).....
	<input type="radio"/> Small (14x9)	05642
	<input type="radio"/> Large (18x12)	05646

- Headrest adjustable - Double ball mounting system  
Available only with backrest Physio Posture

- Large (35x12,5)  05648
- Small (25x12,5)

Large empty rectangular area for order details.

Medium empty rectangular area for order details.

Large empty rectangular area for order details.

**Note**

Large empty rectangular area for notes.

Wheelchair : Progeo EXELLE VARIO - Rev. 2026.1	Prices - VAT excluded to be added to the price list	<p>Send this page only if any optional have been chosen</p> <ul style="list-style-type: none"> <li><input type="checkbox"/> <b>standard</b> (supplied if no requests are indicated)</li> <li><input type="checkbox"/> <b>on request</b> (without extra charge)</li> <li><input type="checkbox"/> <b>optional</b> (cost to be added at the basic price)</li> </ul>
--	--	---



**Enclosure to wheelchair order form - Progeo EXELLE VARIO**

**REFERENCE TABLES**

1	Front height	
With closed frame (95°) max 5" caster		
Casters	Front height	
	min.	max
3"	41	52
4"	42	53
5"	44	54
6"	48	55
7"	50	56
The size of the fork will be defined only by Progeo in accordance with wheelchair final configuration.		

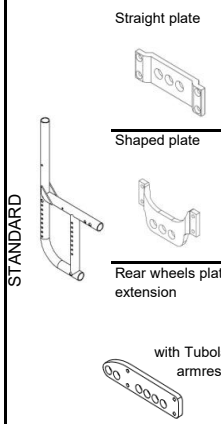
2	Rear height				
Rear frame	Rear wheels				
	22"	24"	25"	26"	
STANDARD 	Straight plate	min. 37 max 45	min. 39 max 47	min. 40 max 48	min. 41 max 49
	Shaped plate	min. 36 max 49	min. 38 max 51	min. 39 max 52	min. 40 max 53
	Rear wheels plate extension	min. 37 max 46	min. 39 max 48	min. 40 max 50	min. 41 max 51
	with Tubular armrests	min. 39 max 46	min. 41 max 48	min. 43 max 50	min. 44 max 51

3	Footplate option	Frame Angle 110°	Footplate distance Frame Angle 120°	Frame Angle 95°
	Plastic footrest	min. 27	min. 27	min. 27
	One piece footplate - Flip-up!	min. 24	min. 26	min. 24
	One piece footplate - Flip-up!, with multifunction rotative system	min. 19,5	min. 21	min. 19,5
	One piece aluminium footplate - Flip-up!	min. 24	min. 26	min. 24
	One piece Carbon fibre footplate	min. 24	min. 26	min. 24
Calculated with the best configuration and with the footplates positioned on inside.				
<b>IMPORTANT NOTICE! From the footplate to the floor minimum 4cm !! (Minimum Front height = DP + 4cm)</b>				

4	Rear wheels	
Model	Features	
22" Ultra-light Progeo - Standard!	(not available in anthracite color)	
24" Ultra-light Progeo - Standard!	(available for all colors)	
24" ULTRA-LIGHT PROGEO KEY SPORT	(silver hub, black rim and 16 spokes)	
24" Ultra-light "Spinergy LX"	(silver hub, black rim and spokes)	
24" Ultra-light "Spinergy LXL"	(black hub and rim, 18 white spokes) - (black hub, rim and 18 spokes)	
24" Ultra-light "Spinergy Flex rim"	(silver hub, black rim and spokes) - (integrated aluminium/rubber handrim - encumbrance reduction up to 3cm. - all tyre)	
24" Off-road	(colour: black) - (aluminium handrim - tyre Off-road)	
25" Ultra-light "Spinergy LX"	(silver hub, black rim and spokes)	
25" Ultra-light "Spinergy LXL"	(black hub and rim, 18 white spokes)	
26" Progeo - Standard!	(colour: black)	
26" Ultra-light "Spinergy LX"	(silver hub, black rim and 18 spokes)	

Wheelchair : Progeo EXELLE VARIO - Rev. 2026.1