

Date User End user weight (kg) Language user manual	Progeo (English) Company stamp Responsible	Rigid frame wheelchair CRASH TEST APPROVED Retail price - VAT not included
--	---	---

Wheelchair measures - The tolerance on all the dimensions indicated and/or required is ± 10 mm	
Seat width (LS) <input type="checkbox"/> 24 <input type="checkbox"/> 27 <input type="checkbox"/> 30 <input type="checkbox"/> 33 <input type="checkbox"/> 36	The seat width is measured from the outer sides of the frame, while the distance between the two side guards is 1 cm wider.
Seat depth (PS) <input type="checkbox"/> 27,5 <input type="checkbox"/> 30 <input type="checkbox"/> 32,5 <input type="checkbox"/> 35 <input type="checkbox"/> 37,5 <input type="checkbox"/> 40	Seat depth can be increased by 2,5 or 5 cm.
Footplate distance (DP) min 8 - max 39,5 (cm) ±0.5cm - adjustment steps 1.5cm	(Real distance between seat and footplate) - IMPORTANT NOTICE! From the footplate to the floor minimum 4cm !! (Minimum Front height = DP + 4cm)
Setting <input checked="" type="checkbox"/> Standard <input type="checkbox"/> Prudential <input type="checkbox"/> Active	
Backrest Height (TS) Std.Value 33,5(min 30,5 - max 51) adjustment steps 1.5cm	
camber <input checked="" type="checkbox"/> 0° <input type="checkbox"/> 2° <input type="checkbox"/> 4°	
Front height (STD 45)	Rear height (STD 41)
Casters 3" (min 35 - max 51)	Rear wheels 22" (min 35 - max 45)
Casters 4" (min 35 - max 52)	Rear wheels 24" (min 37 - max 47)
Casters 5" (min 35 - max 53)	

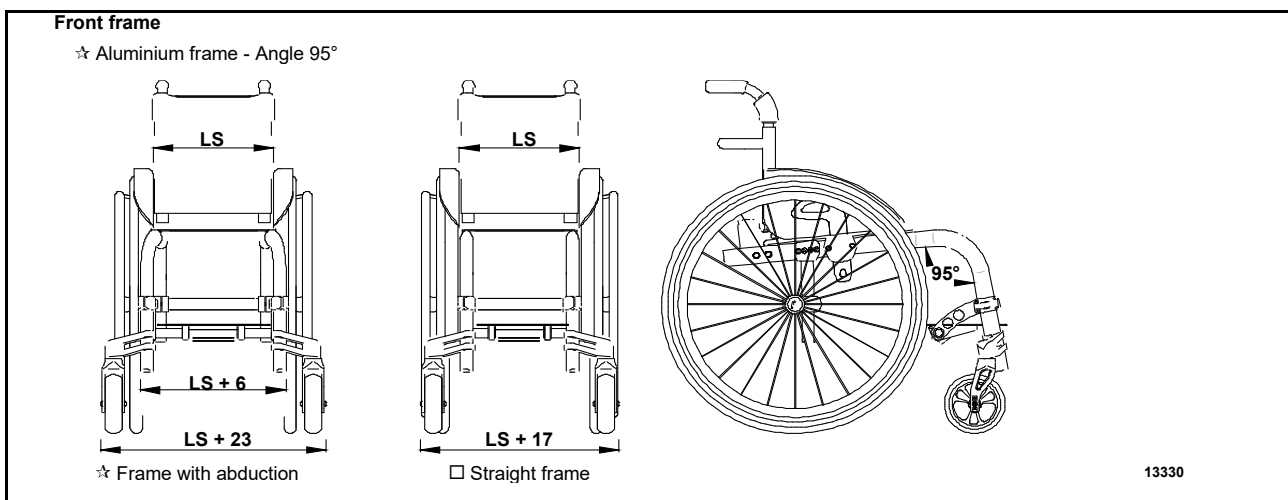

Frame colour

☆ Opaque black

<input type="checkbox"/> POLAR white	<input type="checkbox"/> Matt orange
<input type="checkbox"/> Matt grey	<input type="checkbox"/> Neon Green
<input type="checkbox"/> Matt Midnight blue	<input type="checkbox"/> Mercury Grey
<input type="checkbox"/> Matt red	<input type="checkbox"/> Pop Magenta

Footplate

☆ One piece aluminium footplate - Flip-up! FLIP-UP! - rake and depth adjustable

Footplate distance (min 8 - max 39,5)

11524

Backrest with double locking (upright and folded) (with rake adjustable from -4° to +16°)

☆ Aluminium backrest

☆ Adjustable velcro straps and padded transpiring upholstery

Handle tube

☆ Tubes with standard handle

Folding handles **Minimum backrest height 30,5cm**

Not available with: Push handles for companion

02958

Date	Order	User	Address
------------	-------------	------------	---------------



<p>Fork colour</p> <p>☆ Opaque black</p> <p>○ POLAR white</p> <p>○ Matt grey</p> <p>○ Matt Midnight blue</p> <p>○ Matt red</p> <p style="text-align: right;">08342 75,00</p>	<p>Colour rear wheels</p> <p>To be matched only with:Rear wheels Ultra-light Progeo - Standard! (22-24)</p> <p>☆ Black</p> <p>○ POLAR white</p> <p>○ Matt grey</p> <p>○ Matt Midnight blue</p> <p>○ Matt red</p> <p style="text-align: right;">04692 75,00</p>
---	---

Casters			
☆ 4" Soft			
<input type="checkbox"/> 3" Sport	<i>Lightest configuration</i>		
<input type="checkbox"/> 5" Soft			
<input type="checkbox"/> 3" Active Soft (wide)	(Aluminium alloy rim)		06824
<input type="checkbox"/> 4" Active Sport (narrow)	(Aluminium alloy rim)		01398
<input type="checkbox"/> 4" Active Soft (wide)	(Aluminium alloy rim)		03943
<input type="checkbox"/> 5" Active Soft (wide)	(Aluminium alloy rim)		07518
<input type="checkbox"/> 5" Pneumatic			10844

Rear wheels			
☆ 24" Ultra-light Progeo - Standard!			
<input type="checkbox"/> 22" Ultra-light Progeo - Standard!			
<input type="checkbox"/> 24" ULTRA-LIGHT PROGEO KEY SPORT	<i>Lightest configuration</i>		04383
<input type="checkbox"/> 24" Ultra-light "Spinergy LX"			
<input type="checkbox"/> 24" Ultra-light "Spinergy LXL"	<input type="checkbox"/> Black hub and white spokes	<input type="checkbox"/> Hub and spokes black	07846
<input type="checkbox"/> 24" Ultra-light "Spinergy Flex rim"	<i>Integrated aluminium/rubber handrim</i>		02270
<input type="checkbox"/> 24" Off-road (aluminium handrim black - Wheel distance 4cm)			

Rear wheel tyre			
☆ High pressure tyre	(22"-24")	<i>Lightest configuration</i>	
<input type="checkbox"/> High pressure profile tyre (24")			
<input type="checkbox"/> Marathon Plus	(24")	with anti-puncture protection	01669
<input type="checkbox"/> Anti-puncture - Colour Grey	(22")		04181
<input type="checkbox"/> Anti-puncture - Colour Black	(24")		11083
Not available with Rear wheels : 24" ULTRA-LIGHT PROGEO KEY SPORT, 24" Ultra-light "Spinergy LXL"			

Handrim			
		Wheel distance	☆ 3 cm <input type="checkbox"/> 4 cm
☆ Aluminium	(22"-24")	<i>Lightest configuration</i>	
<input type="checkbox"/> Aluminium black SOFT-TOUCH	(24")		09170
<input type="checkbox"/> Chromed Steel	(24")		01684
<input type="checkbox"/> Titanium	(24")		00016
<input type="checkbox"/> Ultra Grepp	(24")		00017
<input type="checkbox"/> TOP FRICTION	(24")		11023
<i>Oval countour with a rubber insert</i>			
<input type="checkbox"/> NOVA H	(24")		11025
<i>Ergonomic black profile</i>			
<input type="checkbox"/> NOVA D	(24")		11026
<i>Ergonomic profile with rubber coating (ideal for quadripelgics)</i>			
<input type="checkbox"/> Silicon cover for standard aluminium handrim	<i>Available for measures (22"-24")</i>		04050

Wheel locks		
☆ Bent lever push to lock		
<input type="checkbox"/> Straight lever push to lock		
<input type="checkbox"/> Straight lever pull to lock		
<input type="checkbox"/> Brake with extension lever push to lock		01949
<input type="checkbox"/> Brake with extension lever pull to lock		03372

Date	Order	User	Address
------------	-------------	------------	---------------

Mudguard

Removable ABS mudguard

Removable ABS fibre straight sideguard  03946

Removable carbon fibre mudguard

Removable Carbon fibre straight sideguard 03946

Armrests

Tubular armrests (Swing away, removable and height adjustable armrest)

Height assembly (to the seat): 27 28,5 30 31,5 33 34,5 36  04828

Removable armrest with integrated mudguard

Removable armrest with ABS straight sideguard  08881

Removable armrest with carbon-fiber straight sideguard 08882

SAFETY

4 points tie-down system rings (installation must be carried out by the manufacturer)
A head restraint suitable for transportation must be available and fitted accordingly during transportation.

 08654

Accessories

Pad for front frame protectors 07058

Backrest-seat connection cloth 10241

Removable storage bag (with quick coupling) 09811

Optional 1

Anti-tipper with rapid hookup (inside rotation to reduce the encumbrance)
The first is provided free of charge Right Left

The second has extra charge _____ Right Left  06821
06822

Optional 2

One piece Push handle for companion (Removable and height adjustable)  08930

Push handles for companion (Removable and height adjustable)  03645

Tetraclip (Quick release axle for quadriplegic) 03947

Safety pelvic belt 03972

Harness 04103

Lumbar support (to insert in the backrest upholstery) 00013

Swing away lateral support (to insert in the backrest upholstery) Not available with Posture backrest PHYSIO - Posture backrest A I R

Right 02097
 Left 02098 

Spoke guards Black (22"-24") 01043

Spoke guards Transparent (22"-24") 00835

Spoke guards Progeo design (22"-24") 00019

Additional Kit

24" Off-road rear wheels Off-Road tyre - aluminium handrim (black colour) 03378

24" FAT rear wheels FAT tyre 3" - aluminium handrim (black colour) 09357

Date Order User Address

.....

PHYSIO - Std. Backrest upholstery not provided



Removable with quick release
Suitable for tubes with diameter 18+26mm
Depth adjustment (4cm)
Angle adjustment ($\pm 18^\circ$)

Posture backrest KID JUNIOR VERSION

- KID** Aluminum shell

WARNING: with this backrest the seat depth is reduced by 5 cm approx.

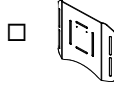





not available for seat width 24

BACKREST HEIGHT	29	34	40
Shell's shape 	Lateral retaining wing R=regular		
	R	R	R
			

Posture backrest ADULT VERSION

- AIR** Carbon shell

not available for seat width 27 - 30

BACKREST HEIGHT	28	34	40			
Shell's shape 	Lateral retaining wing A=high - R=regular					
	A	R	A	R	A	R
						

- POSTURE** Aluminum shell

not available for seat width 27 - 30

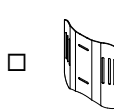
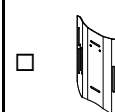
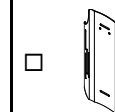
BACKREST HEIGHT	34	40	52
Shell's shape 	Lateral retaining wing R=regular		
	R	R	R
			

Configuration DEEP with side support PAD (height adjustable)

Aluminum lateral with padded, breathable upholstery.



Small (h 13cm)



Right
10272

Left
10272

43,00

Large (h 20cm)



Right
10273

Left
10273

Date Order User Address

Accessories

KID AIR POSTURE

SWING AWAY - Lateral support
Not available for backrest Physio AIR carbon shell
Fixing and adjustment hardware complete with protection sleeve
Alluminum lateral with padded, breathable upholstery.

Large (18x12) 05647
 Small (14x9) 05643
 Lateral support extension Quantity (number pcs)..... 10271
 Lateral support extension Quantity (number pcs).....
 Small (14x9) 05642
 Large (18x12) 05646
 Headrest adjustable - Double ball mounting system 05648
Available only with backrest Physio Posture and Kid

Empty space for additional notes or specifications.

Empty space for additional notes or specifications.

<p>Wheelchair : Progeo JOKER JUNIOR 2.0 - Rev. 2026.1</p>	<p>Prices - VAT excluded to be added to the price list</p>	<p style="text-align: center;">Send this page only if any optional have been chosen</p> <p> <input checked="" type="checkbox"/> standard (supplied if no requests are indicated) <input type="checkbox"/> on request (without extra charge) <input type="checkbox"/> optional (cost to be added at the basic price) </p>
---	--	---