



<u>Date</u> .....	<u>Order</u> .....	<u>User</u> .....	<u>Address</u> .....
-------------------	--------------------	-------------------	----------------------

<b>Casters</b>			
<input checked="" type="checkbox"/> 5" Soft			
<input type="checkbox"/> 4" Soft			
<input type="checkbox"/> 3" Sport		<i>Lightest configuration</i>	
<input type="checkbox"/> 6" Soft			
<input type="checkbox"/> 6" Pneumatic			
<input type="checkbox"/> 3" Active Soft (wide)	(Aluminium alloy rim)		06824
<input type="checkbox"/> 4" Active Sport (narrow)	(Aluminium alloy rim)		01398
<input type="checkbox"/> 4" Active Soft (wide)	(Aluminium alloy rim)		03943
<input type="checkbox"/> 5" Active Soft (wide)	(Aluminium alloy rim)		07518
<input type="checkbox"/> 5" Pneumatic			10844

<b>Rear wheels</b>			
<input checked="" type="checkbox"/> 24" Ultra-light Progeo - Standard!			
<input type="checkbox"/> 22" Ultra-light Progeo - Standard!			
<input type="checkbox"/> 24" ULTRA-LIGHT PROGEO KEY SPORT	<i>Lightest configuration</i>		04383
<input type="checkbox"/> 24" Ultra-light "Spinergy LX"			01685
<input type="checkbox"/> 24" Ultra-light "Spinergy LXL"			07846
<input type="checkbox"/> 24" Ultra-light "Spinergy Flex rim"	<input type="checkbox"/> Hub and spokes black	<input type="checkbox"/> Black hub and white spokes	02270
<input type="checkbox"/> 24" Off-road (aluminium handrim black - Wheel distance 4cm)	Integrated aluminium/rubber handrim		01392
<input type="checkbox"/> 24" with brake handles for companion (drum brake) (aluminium handrim - Wheel distance 3cm)			03384
<b>Available only with camber 0</b>			
<input type="checkbox"/> One arm drive - (24" rear wheels Aluminium handrim High pressure Tyre) - camber 0°			02103
<input type="checkbox"/> Right <input type="checkbox"/> Left			







  

<b>Rear wheel tyre</b>			
<input checked="" type="checkbox"/> High pressure tyre	(22"-24")	<i>Lightest configuration</i>	
<input type="checkbox"/> High pressure profile tyre	(24")		
<input type="checkbox"/> Marathon Plus	(24")	with anti-puncture protection	01669
<input type="checkbox"/> Anti-puncture - Colour Black	(24")		11083
<b>Not available with Rear wheels : 24" ULTRA-LIGHT PROGEO KEY SPORT, 24" Ultra-light "Spinergy LXL"</b>			
<input type="checkbox"/> Anti-puncture - Colour Grey	(22")		04181

  

<b>Handrim</b>			
	<b>Wheel distance</b>	<input checked="" type="checkbox"/> 3 cm <input type="checkbox"/> 4 cm	
<input checked="" type="checkbox"/> Aluminium	(22"-24")	<i>Lightest configuration</i>	
<input type="checkbox"/> Aluminium black SOFT-TOUCH	(24")		09170
<input type="checkbox"/> Chromed Steel	(24")		01684
<input type="checkbox"/> Titanium	(24")		00016
<input type="checkbox"/> Ultra Grepp	(24")		00017
<input type="checkbox"/> TOP FRICTION	(24")		11023
<b>Oval countour with a rubber insert</b>			
<input type="checkbox"/> NOVA H	(24")		11025
<b>Ergonomic black profile</b>			
<input type="checkbox"/> NOVA D	(24")		11026
<b>Ergonomic profile with rubber coating (ideal for quadriplegics)</b>			
<input type="checkbox"/> Silicon cover for standard aluminium handrim		Available for measures (22"-24")	04050

<b>Wheel locks</b>			
<input checked="" type="checkbox"/> Bent lever push to lock			
<input type="checkbox"/> Straight lever push to lock			
<input type="checkbox"/> Straight lever pull to lock			
<input type="checkbox"/> Sport brake			06428
<input type="checkbox"/> Brake with extension lever push to lock			01949
<input type="checkbox"/> Brake with extension lever pull to lock			03372

<b>Footplate - See reference tables N°3</b>			
<input checked="" type="checkbox"/> Plastic footrest with multifunction rotative system			11739
<b>(Minimum footplate distance 16,5cm.)</b>			
<input type="checkbox"/> One piece aluminium footplate - Flip-up! with multifunction rotative system			11740
<b>(Minimum footplate distance 16,5cm.)</b>			

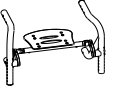

Date ..... Order ..... User ..... Address .....

.....





**PHYSIO - Std. Backrest upholstery not provided**

Removable with quick release  
Suitable for tubes with diameter 18+26mm  
Depth adjustment (4cm)  
Angle adjustment (±18°)

**Posture backrest KID JUNIOR VERSION**







- KID** Aluminum shell

*WARNING: with this backrest the seat depth is reduced by 5 cm approx.*





BACKREST HEIGHT	29	34	40
Shell's shape	Lateral retaining wing R=regular		
	R	R	R
	<input type="checkbox"/> 	<input type="checkbox"/> 	<input type="checkbox"/> 

**Posture backrest ADULT VERSION**

- AIR** Carbon shell  
*not available for seat width 27 - 30*

BACKREST HEIGHT	28	34	40			
Shell's shape	Lateral retaining wing A=high - R=regular					
	A	R	A	R	A	R
	<input type="checkbox"/> 	<input type="checkbox"/> 	<input type="checkbox"/> 	<input type="checkbox"/> 	<input type="checkbox"/> 	<input type="checkbox"/> 

- POSTURE** Aluminum shell  
*not available for seat width 27 - 30*

BACKREST HEIGHT	34	40	52
Shell's shape	Lateral retaining wing R=regular		
	R	R	R
	<input type="checkbox"/> 	<input type="checkbox"/> 	<input type="checkbox"/> 

**Configuration DEEP with side support PAD (height adjustable)**

Aluminum lateral with padded, breathable upholstery.



Small (h 13cm)



Right  
10272

Left  
10272

43,00

Large (h 20cm)



Right  
10273

Left  
10273

Date ..... Order ..... User ..... Address .....

**Accessories**

*KID AIR POSTURE*

SWING AWAY - Lateral support

Not available for backrest Physio AIR carbon shell  
Fixing and adjustment hardware complete with protection sleeve  
Alluminum lateral with padded, breathable upholstery.

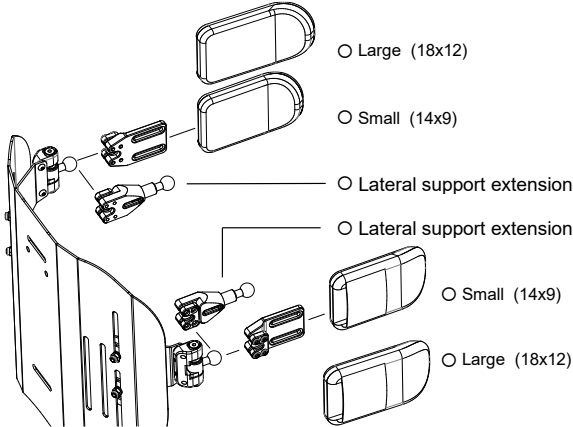

Large (18x12)

05647

Small (14x9)

05643

Lateral support extension

Quantity (number pcs).....

10271

Lateral support extension

Quantity (number pcs).....

Small (14x9)

05642

Large (18x12)

05646

Headrest adjustable - Double ball mounting system  
Available only with backrest Physio Posture and Kid

Large (35x12,5)  
 Small (25x12,5)



05648

Empty space for additional notes or specifications.

Empty space for additional notes or specifications.

Wheelchair : Progeo EXELLE JUNIOR - Rev. 2026.1

Prices - VAT excluded  
to be added to the price list



Send this page only if any optional have been chosen

standard (supplied if no requests are indicated)

on request (without extra charge)

optional (cost to be added at the basic price)

## REFERENCE TABLES

1	Front height				
With closed frame (100°) max 5" caster					
FORK	Casters				
	3"	4"	5"	6"	7"
SMALL 	min. 36 max 51	min. 37 max 52	min. 38 max 53		
MEDIUM 	min. 40 max 55	min. 41 max 56	min. 42 max 57	min. 43 max 58	
LONG 	min. 44 max 59	min. 45 max 60	min. 46 max 61	min. 47 max 62	
The size of the fork will be defined only by Progeo in accordance with wheelchair final configuration.					

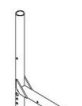
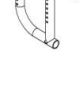
2	Rear height				
Rear frame		Rear wheels			
		22"	24"	25"	26"
STANDARD 	Straight plate	min. 37 max 45	min. 39 max 47		
STANDARD 	Shaped plate	min. 36 max 49	min. 38 max 51		

3	Footplate option	Footplate distance
	Plastic footrest	min. 16,5    max 40,5
	One piece aluminium footplate - Flip-up!	min. 16,5    max 40,5
Calculated with the best configuration and with the footplates positioned on inside.		
<b>IMPORTANT NOTICE! From the footplate to the floor minimum 4cm !! (Minimum Front height = DP + 4cm)</b>		

4	Rear wheels		
	Model	Features	Handrim and tyre
	22" Ultra-light Progeo - Standard!	(not available in anthracite color)	(aluminium handrim and high pressure tyre)
	24" Ultra-light Progeo - Standard!	(available for all couloers)	(all handrim and tyre)
	24" ULTRA-LIGHT PROGEO KEY SPORT	(silver hub, black rim and 16 spokes)	(all handrim and tyre)
	24" Ultra-light "Spinergy LX"	(silver hub, black rim and spokes)	(all handrim and tyre)
	24" Ultra-light "Spinergy LXL"	(black hub and rim, 18 white spokes)	(all handrim and tyre)
	24" Ultra-light "Spinergy Flex rim"	(silver hub, black rim and spokes)	(integrated aluminium/rubber handrim - encumbrance reduction up to 3cm. - all tyre)
	24" Off-road	(colour: black)	(aluminium handrim - tyre Off-road)